



CI-V REFERENCE GUIDE

VHF/UHF TRANSCEIVER

ID-52A

ID-52E

TABLE OF CONTENTS

REMOTE CONTROL	2
Remote control (CI-V) information	2
◇ CI-V data setting.....	2
◇ Connecting to a PC	2
◇ Data format.....	4
◇ Command table	4
◇ Command formats.....	6
• Operating frequency	6
• Operating mode	6
• Offset frequency setting.....	6
• AF gain level setting	6
• Squelch level setting.....	6
• RF power setting	6
• MIC gain (External) setting	6
• VOX gain setting.....	6
• Repeater tone/tone squelch frequency setting	7
• DTCS code and polarity setting.....	7
• Digital code squelch setting	7
• DV MY call sign setting	7
• DV TX call signs setting (24 characters).....	7
• DV TX message setting	8
• DV RX call sign data.....	8
• DV RX message	9
• DV RX Status setting.....	9
• GPS/D-PRS data	9
• GPS/D-PRS message	12
• DV TX data	12
• DV RX data (transceive).....	12
• MY position data	12
• Manually input position data	12

REMOTE CONTROL

Remote control (CI-V) information

◇ CI-V data setting

To control the transceiver, first set the following items on the MENU screen.

① Refer to the Advanced manual for each menu item's details.

[MENU] > SET > Function > **CI-V**

The Icom Communications Interface V (CI-V) is used for remote control.

Set its CI-V address, CI-V Baud Rate (SP Jack)*, and CI-V transceive function*.

* You need to select the baud rate in "CI-V Baud Rate (SP Jack)," when you remotely control the transceiver through the [SP] jack.

When "CI-V Transceive" is set to "ON," the same change as your transceiver is automatically set on other connected transceivers or receivers, and vice versa.

① See page 3 about how to connect a PC to the [SP] jack, through the CT-17 (discontinued product).

[MENU] > SET > Function > **USB Connect**

Before connecting the USB cable to the PC, set "USB Connect" to "Serialport" (default).

[MENU] > SET > Function > **USB Serialport Function**

Before connecting the USB cable to the PC, set "USB Serialport Function" to "CI-V (Echo Back ON)" or "CI-V (Echo Back OFF)."

◇ Connecting to a PC

The transceiver's operating frequency, mode, VFO, and memory selection, can be remotely controlled using a PC.

① Use a proper cable according to your PC's USB port and make the connection as short as possible.

The transceiver may not be recognized by the controller, depending on the USB cable length.

Micro-B ↔ Type-A: User supplied

Micro-B ↔ Type-C: OPC-2418 (optional)

① When connecting to a USB port on your PC with the USB driver installed, USB is named as "ID-52 Serial Port."

If it is recognized correctly, "USB COM" will be displayed on the transceiver.

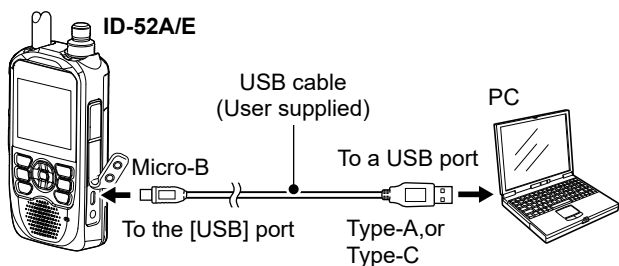

To use the USB cable between the transceiver and a PC, you must first install a USB driver. The latest USB driver and installation guide can be downloaded from the Icom website.

Carefully read the guide, before installing the driver.
<https://www.icomjapan.com/support/>

REMOTE CONTROL

Remote control (CI-V) information

◇ Connecting to a PC

TIP: CI-V connection example

The transceiver can be connected through an optional CT-17 CI-V LEVEL CONVERTER to a PC equipped with an RS-232C port.

① Remote operation through the [SP] jack is not guaranteed.

See the CT-17 instruction manual for details of remotely controlling transceivers and receivers.

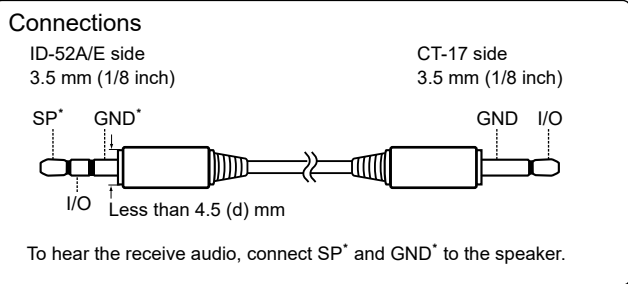
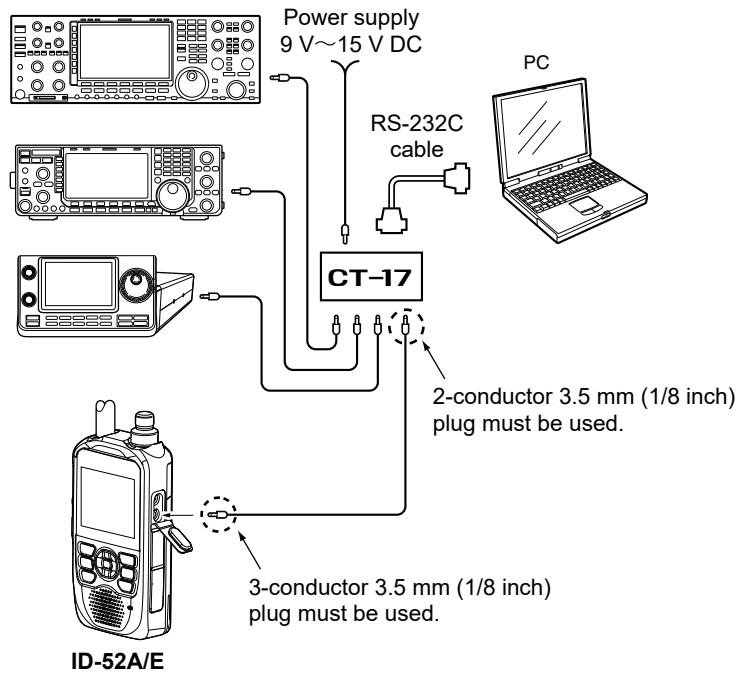

REMOTE CONTROL

Remote control (CI-V) information

◇ Data format

The CI-V system can be written using the following data formats. Data formats differ according to command numbers. A data area or sub command is added for some commands.

Controller to ID-52A/E

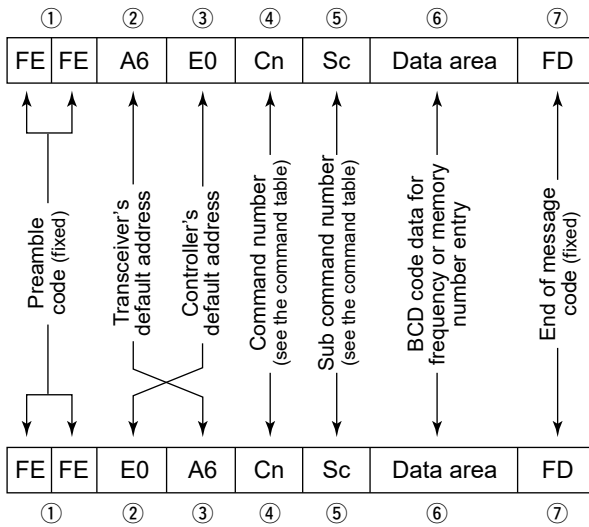

ID-52A/E to controller

OK message to controller

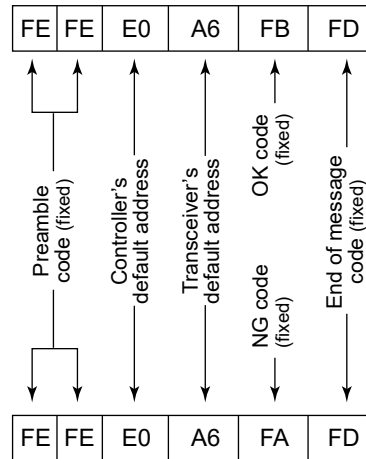

NG message to controller

◇ Command table

Command	Sub	Data	Description
00		See p. 6	Send operating frequency for transceive
01		See p. 6	Send operating mode for transceive
03		See p. 6	Read operating frequency
04		See p. 6	Read operating mode
05		See p. 6	Send operating frequency
06		See p. 6	Send operating mode
07			Select the VFO mode
	D0		Select the A band Dualwatch: Set the MAIN band as the A band Single watch: Select the A band
	D1		Select the B band Dualwatch: Set the MAIN band as the B band Single watch: Select the B band
0C		See p. 6	Read offset frequency*1
0D		See p. 6	Set offset frequency
0F			Read duplex setting (10=OFF, 11=DUP-, 12=DUP+)
	10		Set Simplex
	11		Set Duplex -
	12		Set Duplex +

Command	Sub	Data	Description
11*		00/10/30	Send/read Attenuator (00=OFF, 10=10 dB (375 ~ 479 MHz), 30=30 dB (108 ~ 374.995 MHz))
14*	01	See p. 6	Send/read the audio level
	03	See p. 6	Send/read the squelch level
	0A	See p. 6	Send/read the RF power setting
	0B	See p. 6	Send/read MIC gain (External)
	16	See p. 6	Send/read the VOX gain
15	01	00/01	Read noise or S-meter squelch status (00=Close, 01=Open)
	02	0000 ~ 0255	Read S-meter level (0000=S0, 0170=S9)
	05	00/01	Read various squelch function's (including the tone squelch) status (00=Close, 01=Open)
	11	0000 ~ 0255	Read the Po Meter Level (25=S-Low, 76=Low1, 128=Low2, 179= Mid, 230=High)

*(Asterisk) Send/read data

REMOTE CONTROL

Remote control (CI-V) information

◇ Command table

Command	Sub	Data	Description	
16*	42	00/01	Send/read the Repeater tone (00=OFF, 01=ON)	
	43	00 ~ 02	Send/read the Tone squelch (00=OFF, 01=TSQL, 02=TSQL-R)	
	46	00/01	Send/read the VOX function (00=OFF, 01=ON)	
	4B	00 ~ 02	Send/read the DTCS function (00=OFF, 01=DTCS, 02=DTCS-R)	
	59	00		Send/read SUB band OFF
		01		Send/read SUB band ON
	5B	00 ~ 02	Send/read the DSQL (Digital Call Sign squelch)/CSQL (Digital Code squelch) setting (DV mode only) (00=OFF, 01=DSQL, 02=CSQL)	
	5C	00 ~ 02	Send/read the GPS TX mode (00=OFF, 01=D-PRS, 02=NMEA)	
	5D	00 ~ 09	Send/read the Tone squelch function (00=OFF, 01=TONE, 02=TSQL, 03=DTCS, 04=TSQL-R, 05=DTCS-R, 06=DTCS (T), 07=TONE (T)/DTCS (R), 08=DTCS (T)/TSQL (R), 09=TONE (T)/TSQL (R))	
18	00		Turn OFF the transceiver	
	01*2		Turn ON the transceiver	
19	00		Read the transceiver ID	
1B*	00	See p. 7	Send/read the Repeater tone frequency	
	01	See p. 7	Send/read the TSQL tone frequency	
	02	See p. 7	Send/read the DTCS code and polarity	
	07	See p. 7	Send/read the CSQL code (DV mode)	
1C*	00	00/01	Send/read the transceiver's status (00=RX, 01=TX)	
1F*	00	See p. 7	Send/read the My Call Sign setting	
	01	See p. 7	Send/read the DV TX Callsign setting	
	02	See p. 8	Send/read the DV TX Message setting	
20	00	00*	00/01*3	Send/read the Auto DV RX Call signs output (00=OFF, 01=ON)
		01	See p. 8	Output DV RX Call signs for transceive
		02	See p. 8	Read Auto DV RX Call signs
	01	00*	00/01*3	Send/read the Auto DV RX message output (00=OFF, 01=ON)
		01	See p. 9	Output DV RX message for transceive
		02	See p. 9	Read Auto DV RX message
	02	00*	00/01*3	Send/read the Auto DV RX status output (00=OFF, 01=ON)
		01	See p. 9	Output DV RX status for transceive
		02	See p. 9	Read Auto DV RX status

Command	Sub	Data	Description		
20	03	00*	00/01	Send/read the Auto DV RX GPS/D-PRS data output (00=OFF, 01=ON)	
		01	See p. 9 and 11	Output DV RX GPS/D-PRS data for transceive	
		02	See p. 9 and 11	Read DV RX GPS/D-PRS data for transceive	
	04	00*	00/01	Send/read Auto DV RX GPS/D-PRS message output (00=OFF, 01=ON)	
		01	See p. 12	Output DV RX D-PRS message for transceive	
		02	See p. 12	Read Auto DV RX D-PRS message status	
	22	00		See p. 12	Set the DV TX data (Up to 30 byte)
		01	00	00/01	Set the Auto DV RX data output (00=OFF, 01=ON)
01			See p. 12	Set the DV RX data for transceive (Up to 30 byte)	
02*			00/01	Send/read DV data TX setting (00=PTT, 01=Auto)	
03*			00/01	Send/read DV fast data setting (00=OFF, 01=ON)	
04*			00/01	Send/read GPS Data Speed setting (00=Slow, 01=Fast)	
05*		00 ~ 10	Send/read TX Delay (PTT) setting (00=OFF, 01=1 sec. ~ 10=10 sec.)		
23	00		See p. 12	Read the position status	
	01*		00/01/03	Send/read the internal GPS OFF (00=OFF, 01=Internal GPS, 03=Manual)	
		02*		See p. 12	Send/read the manually input position data
24	00	00*	00/01	Send/read TX output power setting (00=OFF, 01=ON)	
		01	00/01	Set the TX output power for transceive (00=OFF, 01=ON)	

*(Asterisk) Send/read data

*1 Less than 100 Hz is omitted.

*2 When sending the power ON command (18 01) using the [SP] jack (p. 3), the command "FE" must be sent before the basic format. The following is the approximate number of needed repetitions.

•4800bps: 15 "FE"s

•9600bps: 30 "FE"s

•19200bps: 60 "FE"s

Example: When operating with 4800 bps

		①	②	③	④	⑤	⑦
F	E	F	E	A	6	E	0 1 8 0 1 F D

×15

① Preamble code (fixed)

② Transceiver's default address

③ Controller's default address

④ Command number

⑤ Sub command number

⑦ End of message code (fixed)

*3 Output setting is automatically set to OFF after turning OFF the transceiver.

Remote control (CI-V) information

◇ Command formats

• Operating frequency

Command: 00, 03, 05

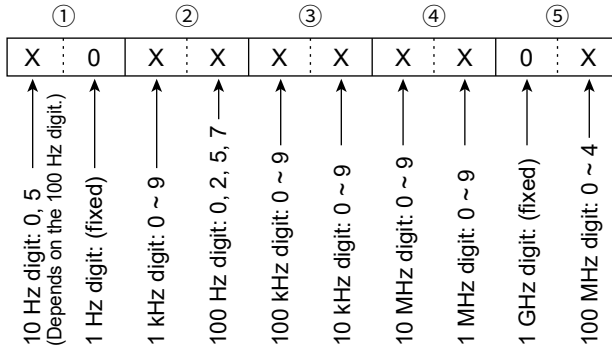

① When the 100 Hz digit is 2 or 7, the 10 Hz digit is fixed to 5 and is fixed to 0 otherwise.

• Operating mode

Command: 01, 04, 06

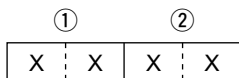

Receive mode	① Operating mode	② Filter setting
FM	05	01
FM-N	05	02
DV	17	01
AM	02	01
AM-N	02	02

• Offset frequency setting

Command: 0C, 0D

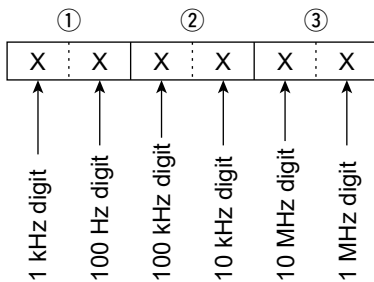

• AF gain level setting

Command: 14 01

VOL0	VOL1	VOL2	VOL3
0000 ~ 0005	0006 ~ 0012	0013 ~ 0018	0019 ~ 0025
VOL4	VOL5	VOL6	VOL7
0026 ~ 0031	0032 ~ 0037	0038 ~ 0044	0045 ~ 0050
VOL8	VOL9	VOL10	VOL11
0051 ~ 0057	0058 ~ 0063	0064 ~ 0069	0070 ~ 0076
VOL12	VOL13	VOL14	VOL15
0077 ~ 0082	0083 ~ 0089	0090 ~ 0095	0096 ~ 0101
VOL16	VOL17	VOL18	VOL19
0102 ~ 0108	0109 ~ 0114	0115 ~ 0121	0122 ~ 0127
VOL20	VOL21	VOL22	VOL23
0128 ~ 0133	0134 ~ 0140	0141 ~ 0146	0147 ~ 0153
VOL24	VOL25	VOL26	VOL27
0154 ~ 0159	0160 ~ 0165	0166 ~ 0172	0173 ~ 0178
VOL28	VOL29	VOL30	VOL31
0179 ~ 0185	0186 ~ 0191	0192 ~ 0197	0198 ~ 0204
VOL32	VOL33	VOL34	VOL35
0205 ~ 0210	0211 ~ 0217	0218 ~ 0223	0224 ~ 0229
VOL36	VOL37	VOL38	VOL39
0230 ~ 0236	0237 ~ 0242	0243 ~ 0249	0250 ~ 0255

• Squelch level setting

Command: 14 03

OPEN*	AUTO	LEVEL1	LEVEL2
0000 ~ 0022	0023 ~ 0046	0047 ~ 0069	0070 ~ 0092
LEVEL3	LEVEL4	LEVEL5	LEVEL6
0093 ~ 0115	0116 ~ 0139	0140 ~ 0162	0163 ~ 0185
LEVEL7	LEVEL8	LEVEL9	
0186 ~ 0208	0209 ~ 0232	0233 ~ 0255	

*Except the DV mode.

• RF power setting

Command: 14 0A

S-Low	Low1	Low2	Mid
0000 ~ 0050	0051 ~ 0101	0102 ~ 0153	0154 ~ 0204
High			
0205 ~ 0255			

• MIC gain (External) setting

Command: 14 0B

1	2	3	4
0000 ~ 0063	0064 ~ 0127	0128 ~ 0191	0192 ~ 0255

• VOX gain setting

Command: 14 16

OFF	1	2	3
0000 ~ 0022	0023 ~ 0046	0047 ~ 0069	0070 ~ 0092
4	5	6	7
0093 ~ 0115	0116 ~ 0139	0140 ~ 0162	0163 ~ 0185
8	9	10	
0186 ~ 0208	0209 ~ 0232	0233 ~ 0255	

Remote control (CI-V) information

◇ Command formats

• **Repeater tone/tone squelch frequency setting**

Command: 1B 00, 1B 01

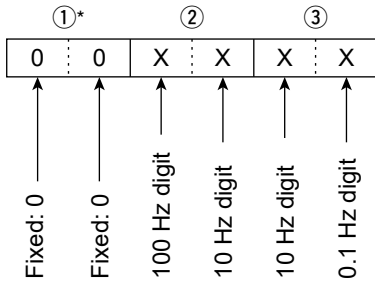

*No input required when setting the frequency.

Refer to the Advanced manual for the tone frequency list.

• **DTCS code and polarity setting**

Command: 1B 02

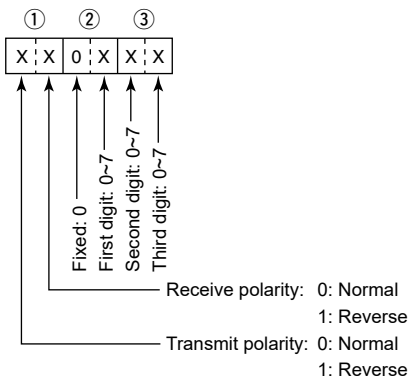

Refer to the Advanced manual for the DTCS code list.

• **Digital code squelch setting**

Command: 1B 07

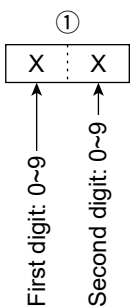

• **DV MY call sign setting**

Command: 1F 00

Set your own call sign and note of up to 12 characters.

See "Character's code of the call sign."

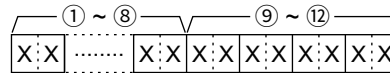

① ~ ⑧: Your own call sign setting (8 characters)
⑨ ~ ⑫: Note setting (4 characters)

• **DV TX call signs setting (24 characters)**

Command: 1F 01

Set "UR," "R1," and "R2" call signs of 8 characters (fixed).

See "Character's code of the call sign."

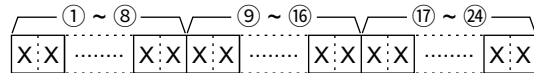

① ~ ⑧: UR (Destination) call sign setting (8 characters)
⑨ ~ ⑮: R1 (Access/Area repeater) call sign setting (8 characters)
⑰ ~ ⑳: R2 (Link/Gateway repeater) call sign setting (8 characters)

Character's code of the call sign

Character	ASCII code
0 ~ 9	30 ~ 39
A ~ Z	41 ~ 5A
(Space)	20
/	2F

Remote control (CI-V) information

◇ Command formats

• DV TX message setting

Command: 1F 02

Set the transmit message of up to 20 characters.

See “Codes for character entries.”

“FF” stops sending or reading messages.

Codes for character entries

Character	ASCII code	Character	ASCII code
A ~ Z	41 ~ 5A	a ~ z	61 ~ 7A
0 ~ 9	30 ~ 39	Space	20
!	21	#	23
\$	24	%	25
&	26	\	5C
?	3F	“	22
,	27	`	60
^	5E	+	2B
-	2D	*	2A
/	2F	.	2E
,	2C	:	3A
;	3B	=	3D
<	3C	>	3E
(28)	29
[5B]	5D
{	7B	}	7D
	7C	_	5F
-	7E	@	40

• DV RX call sign data

Command: 20 0001, 20 0002

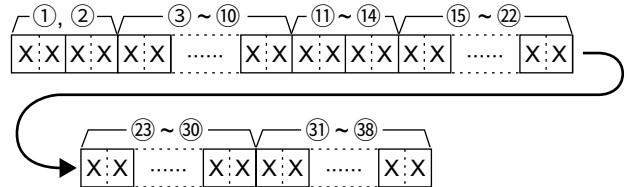

①: Header flag data (First byte)

Data	Description
bit7 (0: Fixed)	—
bit6 (0: Fixed)	—
bit5 (0: Fixed)	—
bit4 0/1	0=Voice, 1=Data
bit3 0/1	0=Direct, 1=Through repeater
bit2 0/1	0=No Break-in, 1=Break-in
bit1 0/1	0=Data, 1=Control
bit0 0/1	0=Normal, 1=EMR

②: Header flag data (Second byte)

Data			Description
bit2	bit1	bit0	
1	1	1	Repeater control
1	1	0	Send auto acknowledge
1	0	1	(Not used)
1	0	0	Request to re-transmit
0	1	1	Send acknowledge
0	1	0	Receive no reply
0	0	1	Repeater disabled
0	0	0	NULL

- ③ ~ ⑩: Call sign of the caller station (8 characters, fixed)
- ⑪ ~ ⑭: Note of the caller station (4 characters, fixed)
- ⑮ ~ ⑳: Call sign of the called station (8 characters, fixed)
- ㉓ ~ ㉟: Call sign of the access/area repeater (R1) (8 characters, fixed)
- ㉑ ~ ㉗: Call sign of the link/gateway repeater (R2) (8 characters, fixed)

See “Codes for character entries.”

①FF: When no call sign is received since the transceiver power was turned ON.

REMOTE CONTROL

Remote control (CI-V) information

◇ Command formats

• DV RX message

Command: 20 0101, 20 0102

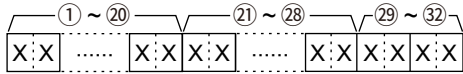

- ① ~ ⑳: Message (20 characters)
 - ㉑ ~ ㉘: Call sign of the caller station (8 characters)
 - ㉙ ~ ㉜: Note of the caller station (4 characters)
- See “Codes for character entries.” (p. 8)
- ①FF: When no call sign is received since the transceiver power was turned ON.

Example: When a Gateway call is received

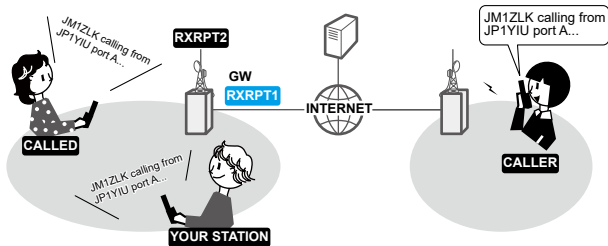

- CALLER: Caller’s call sign
- CALLED: Called station call sign
- RXRPT1: Call sign of the repeater that was accessed by the caller station
 - ① If it was a call through a gateway and the internet, this item displays the gateway call sign of the repeater you received the call from.
- RXRPT2: Call sign of the repeater you received the call from

• DV RX Status setting

Command: 20 0201, 20 0202

Data	Function	Description
bit7	0 (Fixed)	—
bit6	0/1 Receiving a voice call	While receiving a digital voice signal, select “1.” (Regardless of DSQL and CSQL setting)
bit5	0/1 Last call finisher	When the last call was finished by you, select “1.”
bit4	0/1 Receiving a signal	When the audio tone can be heard, select “1.”
bit3	0/1 Receiving a BK call	While receiving a BK call, select “1.”
bit2	0/1 Receiving a EMR call	While receiving a EMR call, select “1.”
bit1	0/1 Receiving a signal other than DV	When “DV” and “FM” are blinking, select “1.”
bit0	0/1 Packet loss status	While displaying packet loss, “1” is returned.

• GPS/D-PRS data

Command: 20 03 0100, 0101, 0102, 0103, 0200, 0201, 0202, 0203

Data number and description

Data number	Description
00	D-PRS — Position
01	D-PRS — Object
02	D-PRS — Item
03	D-PRS — Weather

REMOTE CONTROL

Remote control (CI-V) information

◇ Command formats

- GPS/D-PRS data

Position

Command: 20 03 0100, 20 03 0200

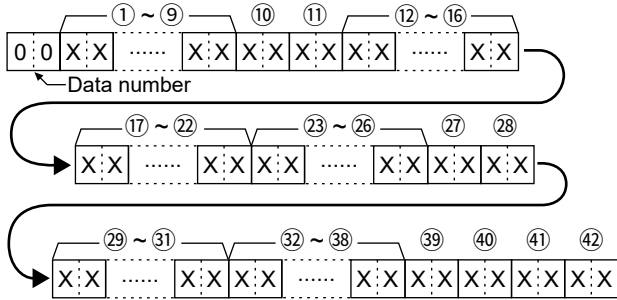

- ① ~ ⑨: Call sign/SSID
(9 ASCII characters (A ~ Z, 0 ~ 9, /, -, space))
- ⑩, ⑪: Symbol (2 ASCII characters (00h ~ EFh))
- ⑫ ~ ⑯: Latitude (dd°mm.mmm format)
- ⑰ ~ ⑳: Longitude (ddd°mm.mmm format)
- ㉓ ~ ㉖: Altitude (0.1 meter steps)
- ㉗, ㉘: Course (1 degree steps)
- ㉙ ~ ㉛: Speed (0.1 km/h steps)
- ㉜ ~ ㉞: Date (UTC: yyyyymmddHHMMSS)
(y: Year, m: Month, d: Day,
H: Hour, M: Minute, S: Second)
- ㉟ ~ ㊲: See the table below.

	㉟ Power	㊰ Height	㊱ Gain	㊲ Directivity
Data	(W)	(m/ft)	(dB)	(deg)
0	0	3/10	0	Omni-direction
1	1	6/20	1	45° NE
2	4	12/40	2	90° E
3	9	24/80	3	135° SE
4	16	49/160	4	180° S
5	25	98/320	5	225° SW
6	36	195/640	6	270° W
7	49	390/1280	7	315° NW
8	64	780/2560	8	360° N
9	81	1561/5120	9	—

- ① The item, that is not contained the received data, is filled with "FF."
- ① FF: No signal has been received since the power was turned ON.

Object

Command: 20 03 0101, 20 03 0201

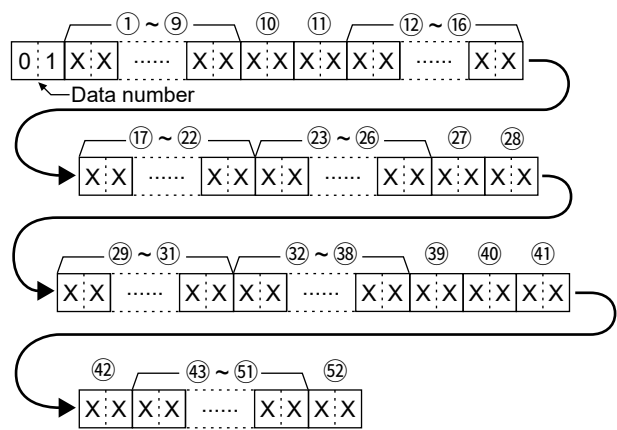

- ① ~ ⑨: Call sign/SSID
(9 ASCII characters (A ~ Z, 0 ~ 9, /, -, space))
- ⑩, ⑪: Symbol (2 ASCII characters (00h ~ EFh))
- ⑫ ~ ⑯: Latitude (dd°mm.mmm format)
- ⑰ ~ ⑳: Longitude (ddd°mm.mmm format)
- ㉓ ~ ㉖: Altitude (0.1 meter steps)
- ㉗, ㉘: Course (1 degree steps)
- ㉙ ~ ㉛: Speed (0.1 km/h steps)
- ㉜ ~ ㉞: Date (UTC: yyyyymmddHHMMSS)
(y: Year, m: Month, d: Day,
H: Hour, M: Minute, S: Second)
- ㉟ ~ ㊲: See the table below.

	㉟ Power	㊰ Height	㊱ Gain	㊲ Directivity
Data	(W)	(m/ft)	(dB)	(deg)
0	0	3/10	0	Omni-direction
1	1	6/20	1	45° NE
2	4	12/40	2	90° E
3	9	24/80	3	135° SE
4	16	49/160	4	180° S
5	25	98/320	5	225° SW
6	36	195/640	6	270° W
7	49	390/1280	7	315° NW
8	64	780/2560	8	360° N
9	81	1561/5120	9	—

- ㉛ ~ ㉝: Name
(9 ASCII characters (00h ~ EFh))
- ㉞: Type (1= Live, 0= Killed)

- ① The item, that is not contained the received data, is filled with "FF."
- ① FF: No signal has been received since the power was turned ON.

REMOTE CONTROL

Remote control (CI-V) information

◇ Command formats

- GPS/D-PRS data

Item

Command: 20 03 0102, 20 03 0202

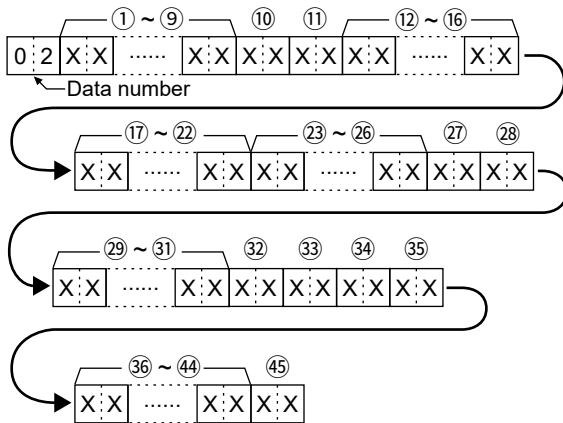

- ① ~ ⑨: Call sign/SSID
(9 ASCII characters (A ~ Z, 0 ~ 9, /, -, space))
- ⑩, ⑪: Symbol (2 ASCII characters (00h ~ EFh))
- ⑫ ~ ⑯: Latitude (dd°mm.mmm format)
- ⑰ ~ ⑳: Longitude (ddd°mm.mmm format)
- ㉓ ~ ㉖: Altitude (0.1 meter steps)
- ㉗, ㉘: Course (1 degree steps)
- ㉙ ~ ㉛: Speed (0.1 km/h steps)
- ㉜ ~ ㉝: See the table below.

	㉜ Power	㉝ Height	㉞ Gain	㉟ Directivity
Data	(W)	(m/ft)	(dB)	(deg)
0	0	3/10	0	Omni-direction
1	1	6/20	1	45° NE
2	4	12/40	2	90° E
3	9	24/80	3	135° SE
4	16	49/160	4	180° S
5	25	98/320	5	225° SW
6	36	195/640	6	270° W
7	49	390/1280	7	315° NW
8	64	780/2560	8	360° N
9	81	1561/5120	9	—

- ㉞ ~ ㉟: Name
(9 ASCII characters (00h ~ EFh))
- ㊱: Type (1= Live, 0= Killed)

- ① The item, that is not contained the received data, is filled with "FF."
- ① FF: No signal has been received since the power was turned ON.

Weather

Command: 20 03 0103, 20 03 0203

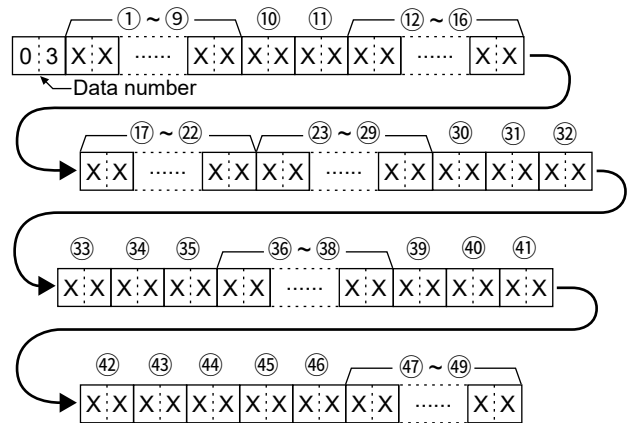

- ① ~ ⑨: Call sign/SSID
(9 ASCII characters (A ~ Z, 0 ~ 9, /, -, space))
- ⑩, ⑪: Symbol (2 ASCII characters (00h ~ EFh))
- ⑫ ~ ⑯: Latitude (dd°mm.mmm format)
- ⑰ ~ ⑳: Longitude (ddd°mm.mmm format)
- ㉓ ~ ㉙: Date (UTC: yyyyymmddHHMMSS)
(y: Year, m: Month, d: Day, H: Hour, M: Minute, S: Second)
- ㉚, ㉛: Wind direction (1 degree steps)
- ㉜, ㉝: Wind speed (0.1 m/s steps)
- ㉞, ㉟: Gust speed (0.1 m/s steps)
- ㊰ ~ ㊱: Temperature (0.1°C steps)
- ㊲: Temperature (0= + degree, 1= - degree)
- ㊳, ㊴: Rainfall (0.1 mm steps)
- ㊵, ㊶: Rainfall (24 hours) (0.1 mm steps)
- ㊷, ㊸: Rainfall (Midnight) (0.1 mm steps)
- ㊹, ㊺: Humidity (1% steps)
- ㊻ ~ ㊽: Barometric pressure (0.1 hPa steps)

- ① The item, that is not contained the received data, is filled with "FF."
- ① FF: No signal has been received since the power was turned ON.

Remote control (CI-V) information

◇ Command formats

• **GPS/D-PRS message**

Command: 20 04 01,20 04 02

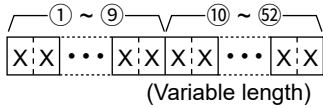

- ① ~ ⑨: Call sign/SSID
(9 ASCII characters (A ~ Z, 0 ~ 9, /, -, space))
- ⑩ ~ ⑫: Message
(Up to 43 ASCII characters (00h ~ EFh))
- ⑬ FF: No signal has been received since the power was turned ON.

• **DV TX data**

Command: 22 00

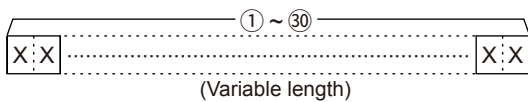

- ① ~ ⑩: TX data (Up to 30 Bytes)
- ⑪ "FA" to "FF" are entered after converted to "FF 0A" to "FF 0F" automatically. Up to 60 bytes of data can be entered in this case.

• **DV RX data (transceive)**

Command: 22 01 01

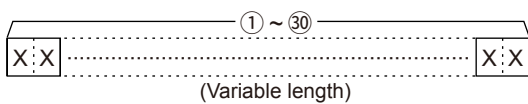

- ① ~ ⑩: RX data (Up to 30 Bytes)
- ⑪ "FA" to "FF" are entered after converted to "FF 0A" to "FF 0F" automatically. Up to 60 bytes of data can be entered in this case.

• **MY position data**

Command: 23 00

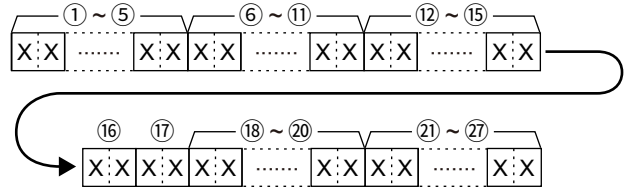

- ① ~ ⑤: Latitude (dd°mm.mmm format)
- ⑥ ~ ⑪: Longitude (ddd°mm.mmm format)
- ⑫ ~ ⑮: Altitude (0.1 meter steps)
- ⑯, ⑰: Course (1 degree steps)
- ⑱ ~ ⑳: Speed (0.1 km/h steps)
- ㉑ ~ ㉓: Date (UTC: yyymmddHHMMSS)
(y: Year, m: Month, d: Day, H: Hour, M: Minute, S: Second)

• **Manually input position data**

Command: 23 02

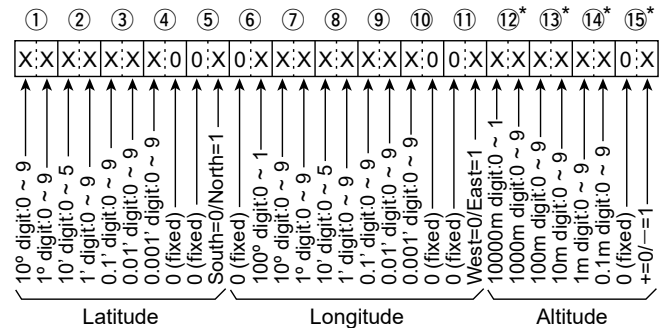

- ① ~ ⑤: Latitude (dd°mm.mmm format)
- ⑥ ~ ⑪: Longitude (ddd°mm.mmm format)
- ⑫ ~ ⑮: Altitude (0.1 meter steps)

*About the Altitude data:

On read: If the received Altitude data is invalid, these bytes are filled with "FF."

On write: If you set no Altitude data, fill these bytes with "FF."

Count on us!

